



USED COOKING OIL CONTAINMENT TANK

MODEL 3073SQ

Indoor version of our space-saving square tank with a larger footprint. Can be housed anywhere indoors, including far away from fryer vats if necessary. Direct-Plumbed®, pump station, and caddy options create added versatility and convenience.

CONSTRUCTION AND FEATURES

- Heavy-gauge stainless steel exterior
- Freestanding, 30 in. l x 30 in. w x 73 in. h (762mm x 762mm x 1855mm)
- Stainless steel tank platform bottom
- Tank capacity 1402 Lb/183 Gal (635 kg/692 l)
- Control panel with power indication or digital reader
- Level indicators with safety overflow protection
- Suitable for Direct-Plumbed®, Remote-Plumbed® or Caddy systems
- Easy to access and service components
- One-year warranty on all parts and components
- Worldwide delivery and installation available

BENEFITS

- Minimal or no handling of hot Used shortening
- Insurance and Workers' Comp savings
- Less employee downtime
- Labor savings and greater employee safety
- Cleaner grounds and image
- Used oil of higher value to collection companies
- Avoid pollution fines

Installation and Operating Specifications

Model	3073SQ-NA Containment Tank
Power Requirements	NA: 110 V 15 A, 60 Hz HV: 250 V 3.5 A, 50/60 Hz
Installation Space Requirements	30 in. l x 30 in. w x 73 in. h (762mm x 762mm x 1855mm)
Shortening Capacity	1402 Lb/183 Gal (635 kg/692 l)
Shipping Weight	882 lb (400 kg)
Documentation	Installation guide, Operating guide
Warranty	One-year parts and labor



USED COOKING OIL CONTAINMENT TANK

MODEL 3073SQ

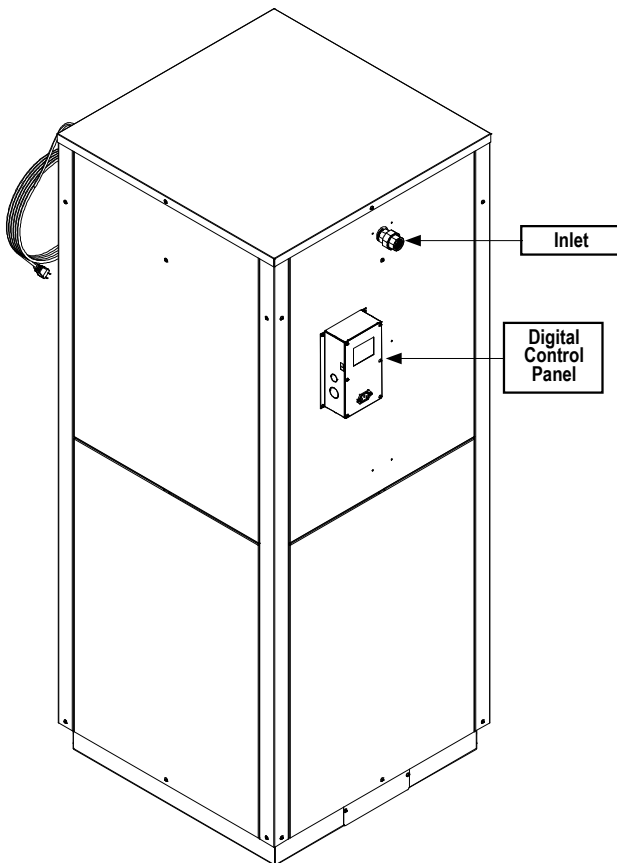
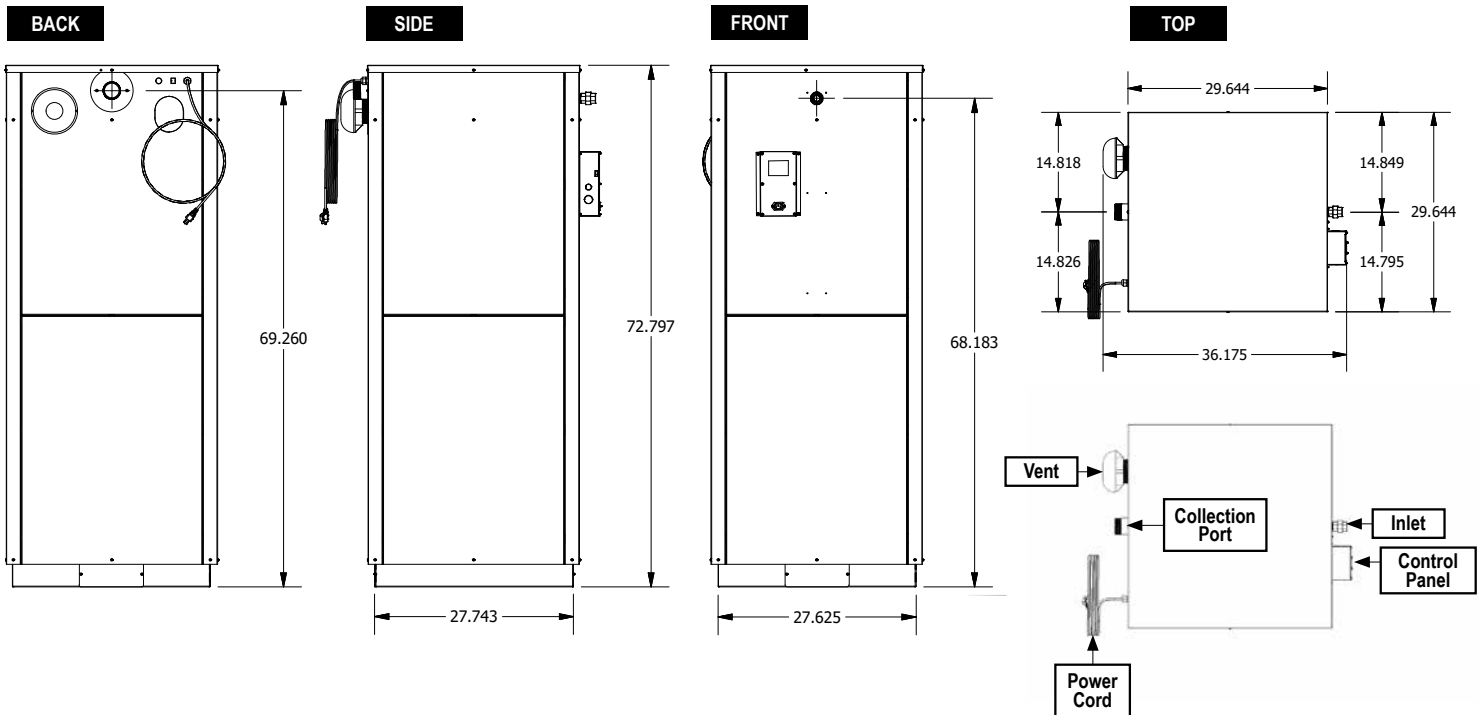

IMPORTANT

- The appliance is not to be used by persons (including children) with reduced physical, sensory or mental capabilities, or lack of experience and knowledge, unless they have been given supervision or instruction.
- Children should be supervised to ensure that they do not play with the appliance.
- If the supply cord is damaged, it must be replaced by the manufacturer, its service agent or similarly qualified persons in order to avoid a hazard.
- Not intended to be operated by means of an external timer or a separate remote-control system.
- This appliance is intended to be used in commercial kitchen applications.

Frontline International, Inc.
187 Ascot Parkway • Cuyahoga Falls, Ohio 44223
330-861-1100 • 877-776-1100 • frontlineii.com
Fax: 330-861-1105 • info@frontlineii.com

FRONTLINE
international

© Frontline International, 11/23